

- | | | | |
|----------|---|---|--|
| 1 | Desligar o disjuntor correspondente à linha em intervenção. | Turn off the circuit breaker corresponding to the intervention line | Désactivez le disjoncteur correspondant à l'intervention en ligne |
| 2 | Realizar marcações da luminária no teto | Make marks in the ceiling for luminaire | Faire des marques dans le plafond pour luminaire |
| 3 | Abrir furo no teto | Open hole in the ceiling | Ouvrir trou dans le plafond |
| 4 | Retirar o cabo de alimentação do teto | Remove the power cord from the ceiling | Retirer le cordon d'alimentation au plafond |
| 5 | Electrifique a luminária | Electrify the luminaire | Electrify le luminaire |
| 6 | Colocar a fonte no teto | Place the driver in the ceiling | Placer le driver dans le plafond |
| 7 | Pressionar as molas no sentido das setas e colocar o aparelho no teto | Press the springs in the direction of the arrows and put the equipment on the ceiling | Appuyez sur les ressorts dans le sens des flèches et de mettre l'équipement sur le plafond |
| 8 | Certifique que o aro fica encostado ao teto | Ensure that the equipment fits properly to the ceiling | Assurez-vous que l'équipement est bien ajusté au plafond |
| 9 | Ligar o disjuntor correspondente à linha em intervenção | Turn on the circuit breaker corresponding to the intervention line | Connectez le circuit correspondant disjoncteur à l'intervention de ligne |

Notas
Notes
Remarque

Este produto contém uma fonte de luz da classe energética A.
This product contains an energy class A light source.
Ce produit contient une source lumineuse de classe énergétique A.

IMPORTANTE: Para mais informação sobre as diferentes arquiteturas, soluções e funcionalidades disponíveis, por favor contactar a Lightenjin.

São Rejeitadas todas as responsabilidades por defeito ou danos provocados por montagem incorrecta da luminária; incorrecta alimentação e agentes externos.

IMPORTANT: For more information about different architectures, solutions and available functionalities, please contact Lightenjin.

Are Rejected all liability for defects or damage caused by incorrect installation of the luminaire; Misfeeding and external agents.

IMPORTANT: Pour plus d'informations sur les différentes architectures de réseau, solutions et fonctionnalités disponibles, contactez Lightenjin.

Sont rejetées toute responsabilité pour les défauts ou les dommages causés par une mauvaise installation du luminaire; Mauvaise alimentation et les agents extérieurs.

Lightenjin II - Indústria de Iluminação, Lda

Parque empresarial do Casarão,
Avenida das 2 Rodas, Lote 36A
3750-041 Aguada de Cima | Portugal

tel: +351. 234 080 117
fax: +351. 234 640 064

geral@lightenjin.pt
www.lightenjin.pt

ELEMENTARE R 280 / 07-08-2018 / IMD1400172A / IMD1400173A



Instruções de montagem
Mounting instructions
Instructions de montage

OFF

1

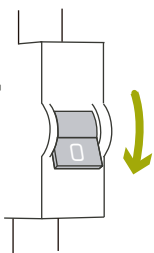

Ver tabela I para o furo
Please see table I for hole
Voir le tableau I pour le trou

2

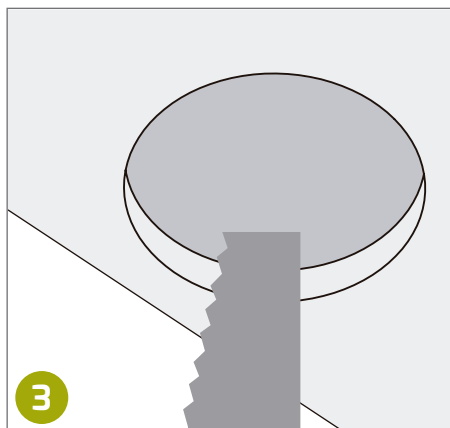
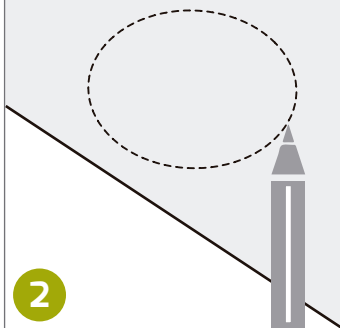

3

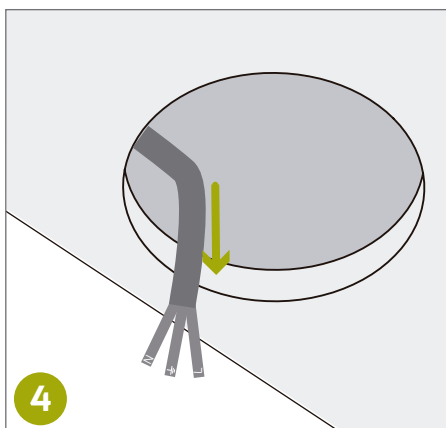

4

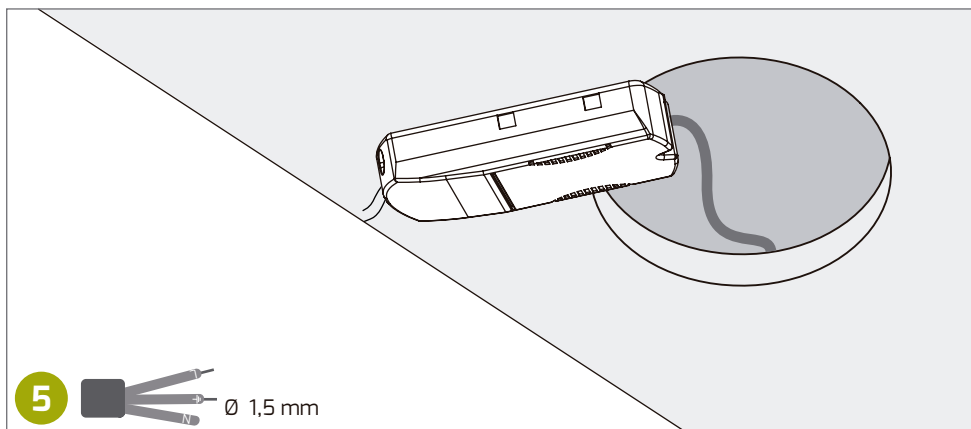

5

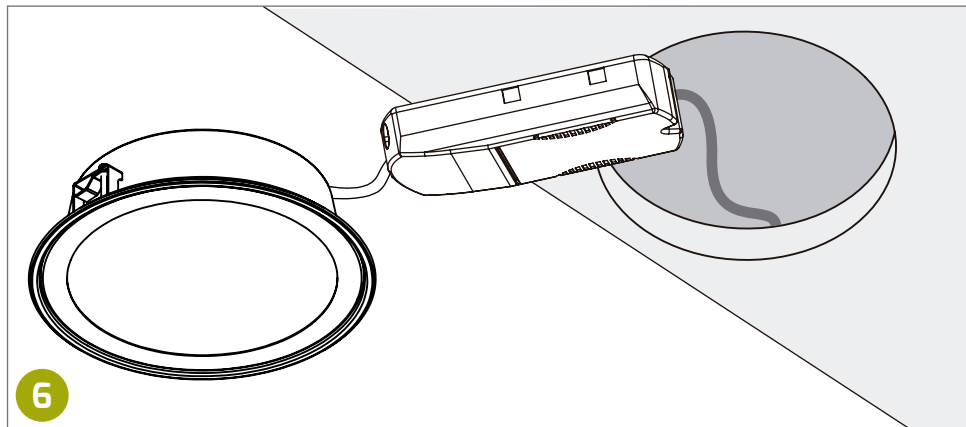

6

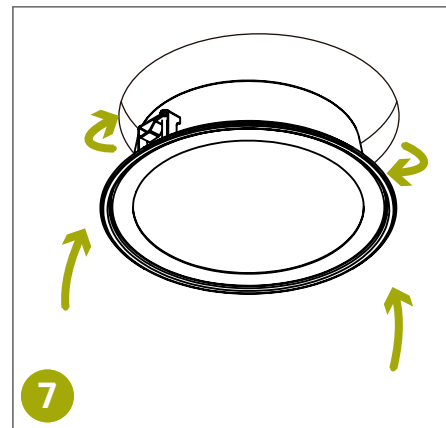

7

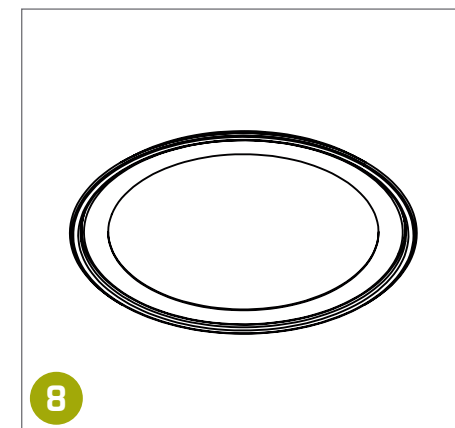

8



Certifique que as ligações ficam bem efetuadas.

Make sure the connections are installed correctly.

Assurez-vous que les connexions sont correctement installées.

TABELA I | TABLE I | TABLE I

Modelo Model Modèle	Diâmetro do Furo Hole Diameter Diamètre du trou (mm)
ELEMENTARE R 280	280

ON!

9

