

SHEER R 180

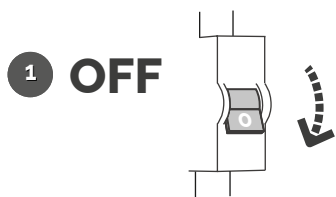

Instruções de montagem
Mounting instructions
Instructions de montage



LIGHTENJIN II - Indústria de Iluminação, Lda
Parque Empresarial do Casarão, Avenida das 2 Rodas,
Lote 36A. 3750-041 Aguada de Cima | Portugal
tel: +351 234 080 117 | fax: +351 234 640 064
geral@lightenjin.pt | www.lightenjin.pt

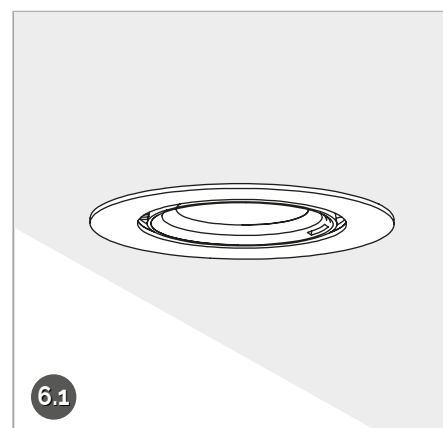
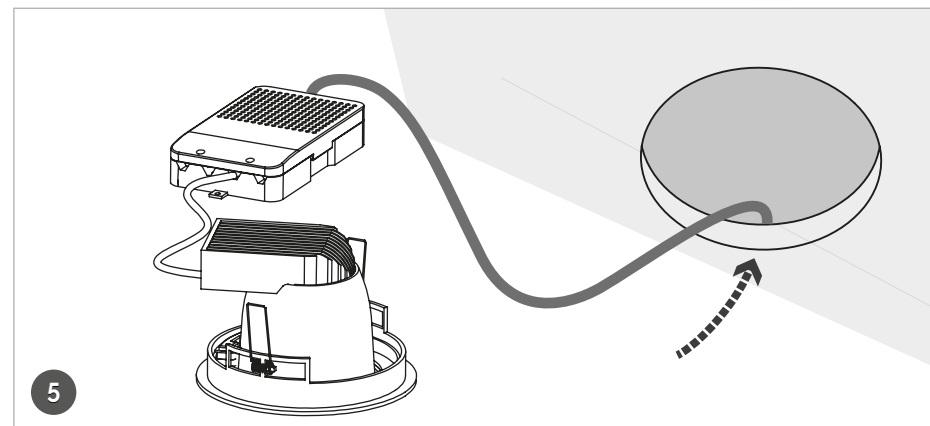
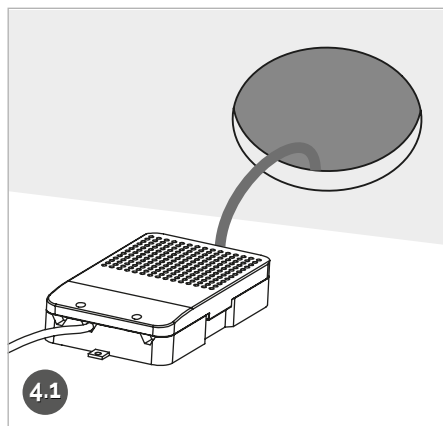
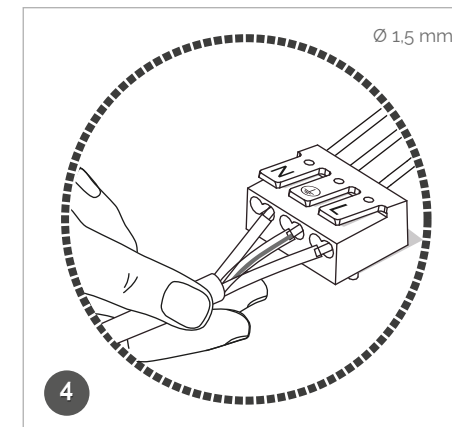
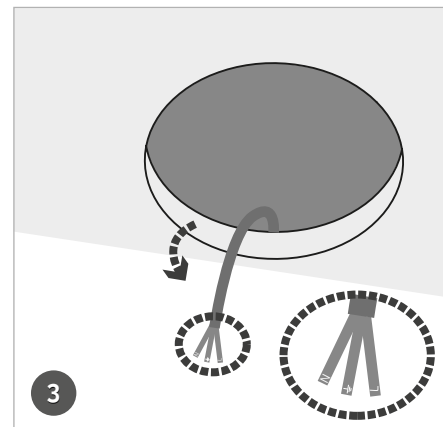
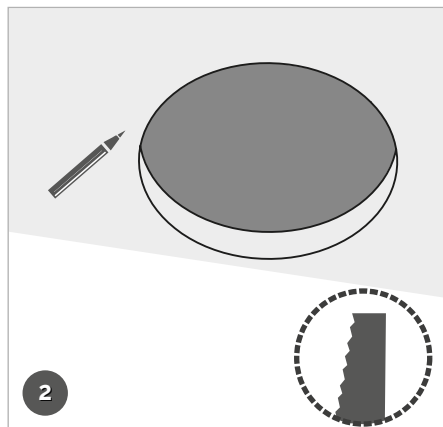

- | | | | |
|------------------|---------------------------------------------------------------------------------------------------------------------------------------------|----------------------------------------------------------------------------------------------------------------------------------------------------|------------------------------------------------------------------------------------------------------------------------------------------------|
| <p>1 </p> | <p>Desligar o disjuntor correspondente à linha em intervenção;</p> | <p>Turn off the circuit breaker corresponding to the intervention line</p> | <p>Désactivez le disjoncteur correspondant à l'intervention en ligne</p> |
| <p>2</p> | <p>Realizar as marcações, e abrir furo no teto;
FURO DO TETO: Ø100 mm</p> | <p>Make the markings and drill a hole in the ceiling;
ROOF HOLE: Ø100 mm</p> | <p>Faites les marques et percez un trou dans le plafond ;
TROU DE TOIT : Ø100 mm</p> |
| <p>3</p> | <p>Retirar o cabo de alimentação do teto;</p> | <p>Remove the power cable from the ceiling;</p> | <p>Retirer le câble d'alimentation du plafond ;</p> |
| <p>4 </p> | <p>Eletrificar a luminária;
CONSULTAR ESQUEMA 1</p> | <p>Electrify the luminaire;
SEE SCHEME 1</p> | <p>Electrifier le luminaire ;
VOIR DIAGRAMME 1</p> |
| <p>5 </p> | <p>Colocar a fonte de alimentação no teto;</p> | <p>Place the power supply on the ceiling;</p> | <p>Placez le bloc d'alimentation au plafond ;</p> |
| <p>6</p> | <p>Pressionar as molas no sentido das setas e aplicar o aparelho no teto;
(*) CERTIFIQUE-SE QUE O ARO FICA ENCOSTADO AO TETO</p> | <p>Press the springs in the direction of the arrows and apply the device to the ceiling;
(*) MAKE SURE THE FRAME RESTS AGAINST THE CEILING</p> | <p>Appuyez sur les ressorts dans le sens des flèches et fixez l'appareil au plafond ;
(*) S'ASSURER QUE LE CADRE REPOSE SUR LE PLAFOND</p> |
| <p>7 </p> | <p>Ligar o disjuntor correspondente à linha em intervenção</p> | <p>Turn on the circuit breaker corresponding to the intervention line</p> | <p>Connectez le circuit correspondant disjoncteur à l'intervention de ligne</p> |

Nota
Note
Remarque

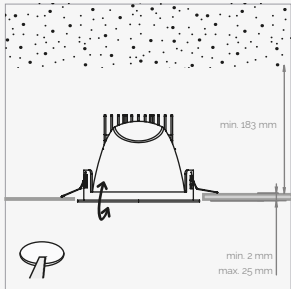

Furo de teto: Ø180 mm
Ceiling hole: Ø180 mm
Trou au plafond : Ø180 mm

Este produto contém uma fonte de luz da classe energética A
This product contains an energy class A light source
Ce produit contient une source lumineuse de classe énergétique A

Esquema 1 | Scheme 1 | Schéma 1

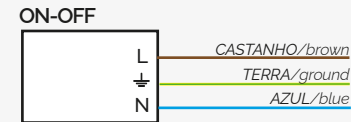

IMPORTANTE: Para mais informação sobre as diferentes arquiteturas, soluções e funcionalidades disponíveis, por favor contactar a Lightenjin.

São Rejeitadas todas as responsabilidades por defeito ou danos provocados por montagem incorrecta da luminária, incorrecta alimentação e agentes externos.

IMPORTANT: For more Information about different architectures, solutions and available functionalities, please contact Lightenjin

Are Rejected all liability for defects or damage caused by incorrect installation of the Luminaire, Misfeeding and external agents.

IMPORTANT: Pour plus d'informations sur les différentes architectures de réseau, solutions et fonctionnalités disponibles, contactez Lightenjin.

Sont rejetées toute responsabilité pour les défauts ou les dommages causés par une mauvaise installation du luminaire, Mauvaise alimentation et les agents extérieurs.

